

# リレーソケット

## 製品仕様

No.	仕様項目	測定条件	単位	
1	絶縁耐圧	端子間	VDC - Min	1000
2	初期接触抵抗	@ Ø 0.45mm	mΩ - Max	15
3	絶縁抵抗	@ 100V 20 °C 65%RH	Ω - Min	10 <sup>12</sup>
4	挿入力	@ Ø 0.45mm	g - Max	600
5	抜去力	@ Ø 0.45mm	g - Min	100
6	適合リード径	-	mm	Ø 0.3 ~ Ø 0.45
7	使用温度範囲	-	°C	- 20 ~ + 80
8	耐久挿抜回数	@ Ø 0.45mm	Cycles - Min	100

## 製品構成部材

No.	部 品	材 質	表面処理
1	スリーブ	黄銅	Au
2	コンタクト	ベリリウム銅	Au
3	基板	ガラスエポキシ (t=0.5mm)	
4	シール	シリコン	

## 外観寸法図 (単位 mm)

DRG.1

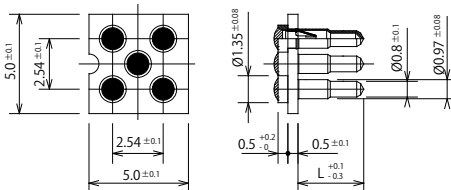

DRG.2

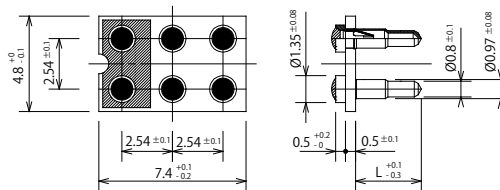

DRG.3

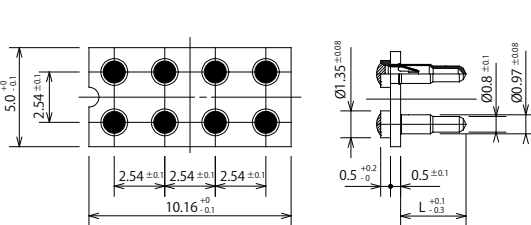

DRG.4

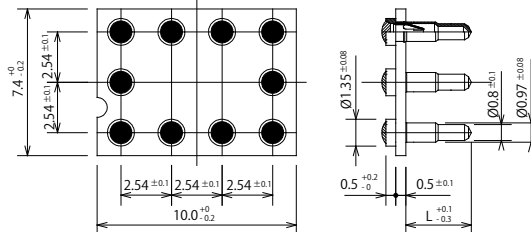



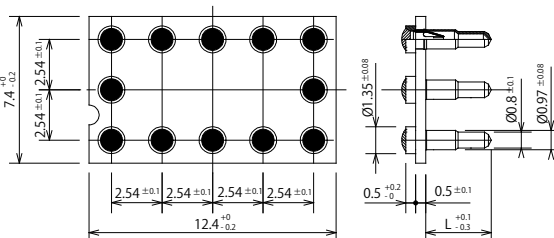

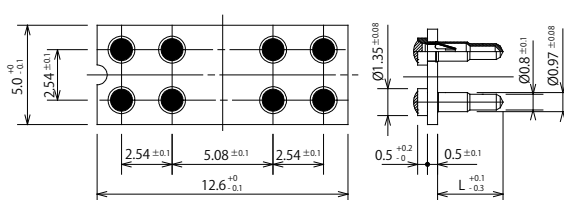

DRG.5

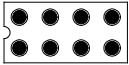
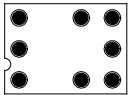
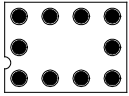
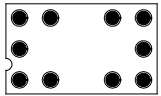
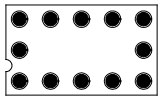

DRG.6

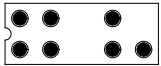

ソケット型名	L(mm)	ピン配置(TOP VIEW)	外觀図	リレータイプ
MFX-5-1.6	3.3		DRG.1	FS-E1□□
MFX-5-3.2	4.0			
MFX-5-4.8	5.3			
MSX-6-1.6	3.3		DRG.2	FS-E2A□□ FS-E1T□□
MSX-6-3.2	4.0			
MSX-6-4.8	5.3			
UFX-8-1.6	3.3		DRG.3	UF-1A□□ UF-2A□□ UF-1T□□
UFX-8-3.2	4.0			
UFX-8-4.8	5.3			
UCX-8A-1.6	3.3		DRG.4	UC-2A□□Z-01
UCX-8A-3.2	4.0			
UCX-8A-4.8	5.3			
UCX-10-1.6	3.3			UC-2T□□ZA-01
UCX-10-3.2	4.0			
UCX-10-4.8	5.3			
SCTX-10-1.6	3.3		DRG.5	SC-2T□□Z
SCTX-10-3.2	4.0			
SCTX-10-4.8	5.3			
SCTX-12-1.6	3.3			SC-E4A□□Z
SCTX-12-3.2	4.0			
SCTX-12-4.8	5.3			
SCX-6A-1.6	3.3		DRG.6	SC-1A□□X
SCX-6A-3.2	4.0			
SCX-6A-4.8	5.3			
SCX-7A-1.6	3.3			SC-1T□□X
SCX-7A-3.2	4.0			
SCX-7A-4.8	5.3			
SCHX-8-1.6	3.3		SC-2A□□X SCH-□2□□G□	
SCHX-8-3.2	4.0			
SCHX-8-4.8	5.3			

外觀寸法図 (単位 mm)

DRG.7

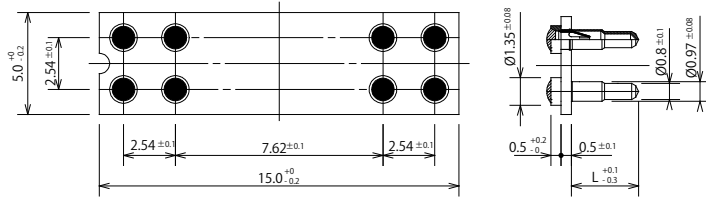

DRG.8

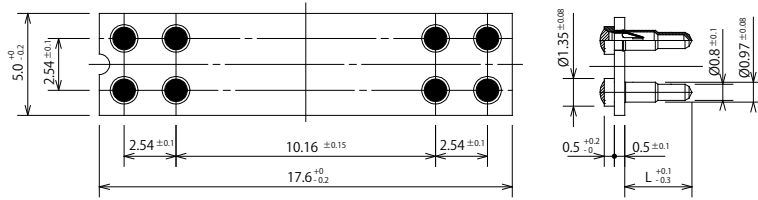

DRG.9

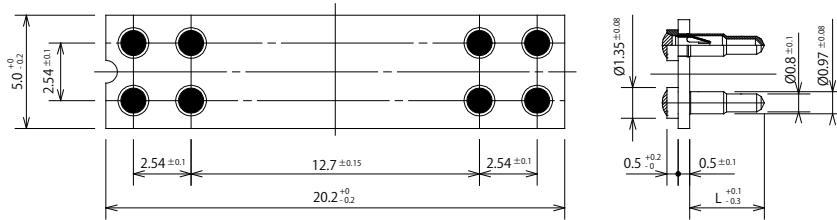

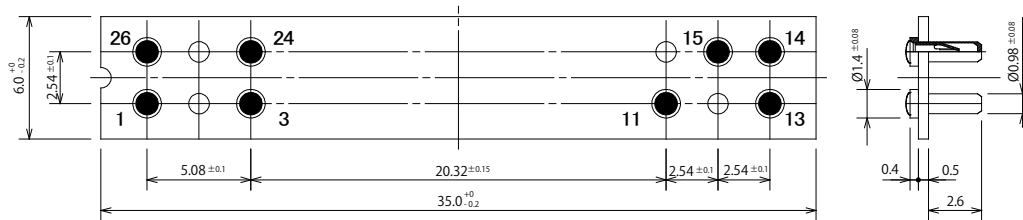

DRG.10

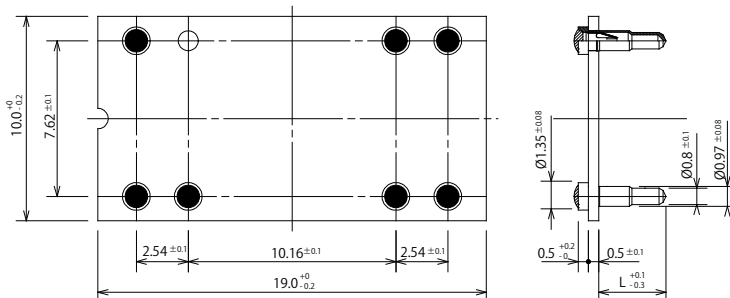

DRG.11

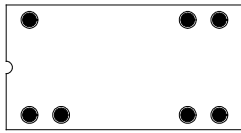

ソケット型名	L(mm)	ピン配置(TOP VIEW)	外観図	リレータイプ			
SMX-6A-1.6	3.3		DRG.7	SMT-1A□□LDN			
SMX-6A-3.2	4.0						
SMX-6A-4.8	5.3						
SMX-7-1.6	3.3			DRG.7	SMT-1□□LDN		
SMX-7-3.2	4.0						
SMX-7-4.8	5.3						
SMX-8-1.6	3.3				DRG.7	SMT-2A□□LDN	
SMX-8-3.2	4.0						
SMX-8-4.8	5.3						
SUX-6B-1.6	3.3		DRG.8			SU-1□□ND	
SUX-6B-3.2	4.0						
SUX-6B-4.8	5.3						
SUX-8-1.6	3.3			DRG.8		SUH-22□□G SUT-2A□□ND SUT-1T□□ND SU□-1□□NME	
SUX-8-3.2	4.0						
SUX-8-4.8	5.3						
SX-4-1.6	3.3				DRG.9	S-1□□W	
SX-4-3.2	4.0						
SX-4-4.8	5.3						
SX-5-1.6	3.3		DRG.9			S-E1□□N S-1□□WG	
SX-5-3.2	4.0						
SX-5-4.8	5.3						
SX-6A-1.6	3.3			DRG.9		S-E1□□NC	
SX-6A-3.2	4.0						
SX-6A-4.8	5.3						
SX-6B-1.6	3.3					DRG.9	S-E1□□ND
SX-6B-3.2	4.0						
SX-6B-4.8	5.3						
SX-7-1.6	3.3				DRG.9		S-1□□TJ
SX-7-3.2	4.0						
SX-7-4.8	5.3						

ソケット型名	L(mm)	ピン配置(TOP VIEW)	外觀図	リレータイプ
SX-8-1.6	3.3		DRG.9	S-1□□TA S□-1□□NME ST-1□□□
SX-8-3.2	4.0			
SX-8-4.8	5.3			
SLX-4-1.6	2.6		DRG.10	SL-162□□
SLX-5-1.6	2.6			SL-162□□GB
SPX-7-1.6	3.3		DRG.11	SP-1□□W□H SP-2□□W□
SPX-7-3.2	4.0			
SPX-7-4.8	5.3			

丸ピンソケット外觀寸法図 単位 mm

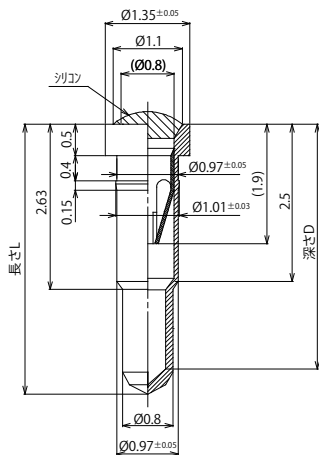

丸ピン型名	長さ L(mm)	深さ D(mm)
SPIN-A-1.6	4.3	3.9
SPIN-A-3.2	5.0	4.1
SPIN-A-4.8	6.3	3.9

部品	材質	表面処理
スリーブ	黄銅	Au
コンタクト	ベリリウム銅	Au

プリント基板穴開け標準寸法 Ø1.1mm